

Giotto 129

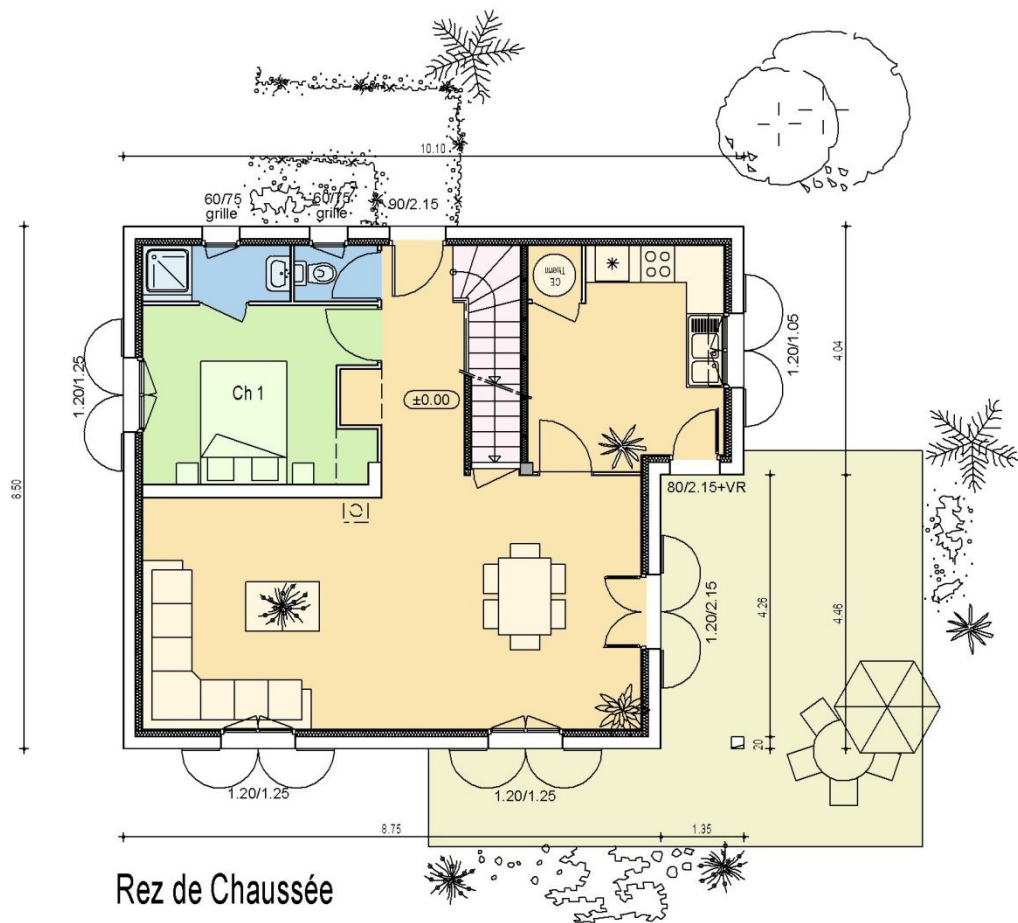

Rez de Chaussée



Etage

Bains	2.16 m ²
Bains	4.95 m ²
Cave 1	20.89 m ²
Cave 2	12.14 m ²
Chambre 1	10.36 m ²
Chambre 2	11.59 m ²
Chambre 3	17.16 m ²
Chambre 4	12.76 m ²
Cuisine	11.33 m ²
Entrée	5.16 m ²
Escalier	3.61 m ²
Espace loisir	16.28 m ²
Garage	35.46 m ²
Salon	32.31 m ²
WC	1.22 m ²
SURFACE AMENAGEE	128.89 m ²
SURFACE HABITABLE	111.40 m ²
SURFACE ANNEXES	68.49 m ²

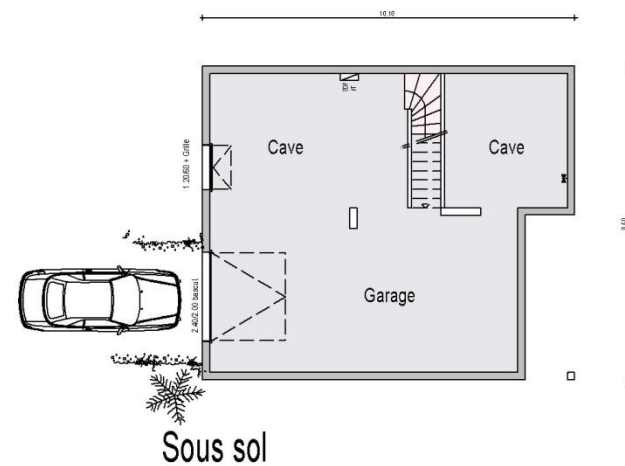

Sous sol

Giotto 135

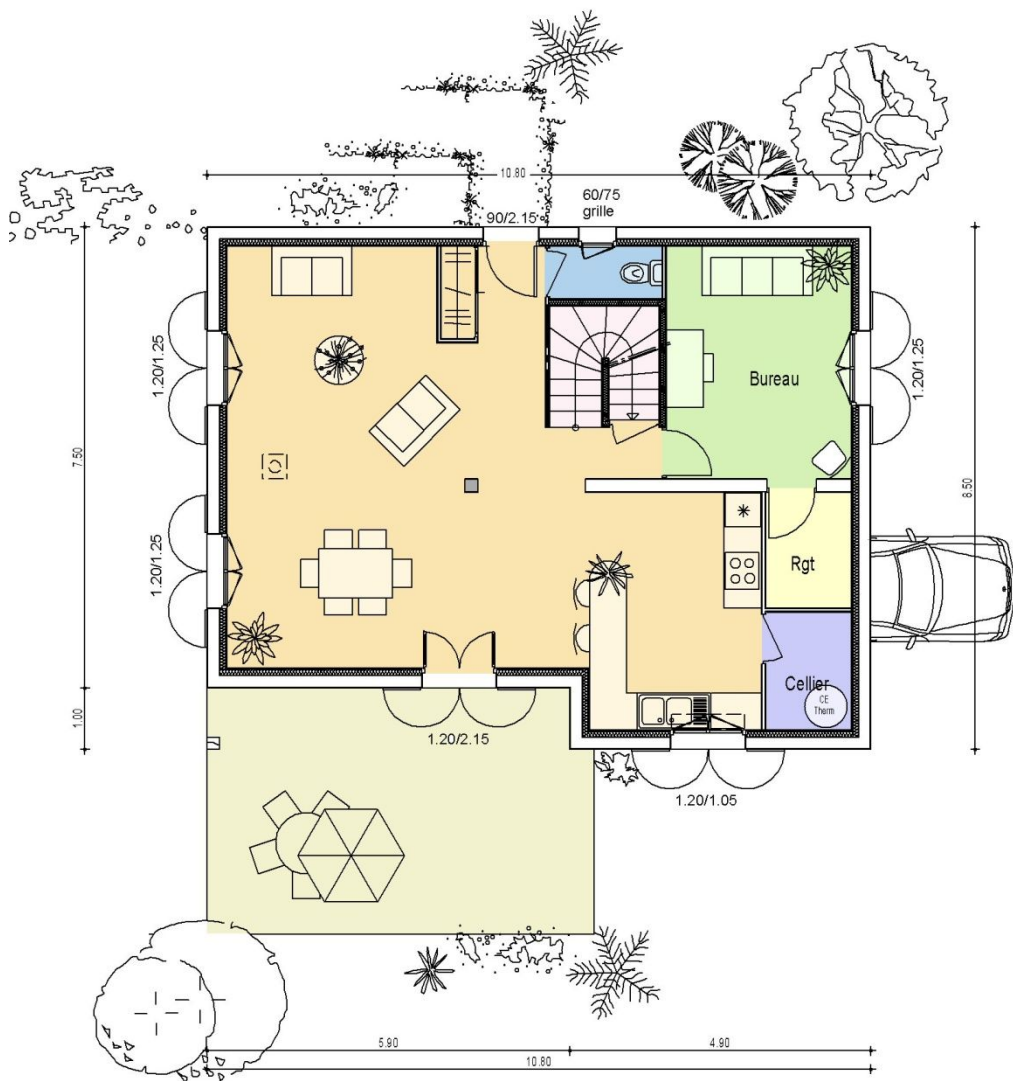

Rez de Chaussée

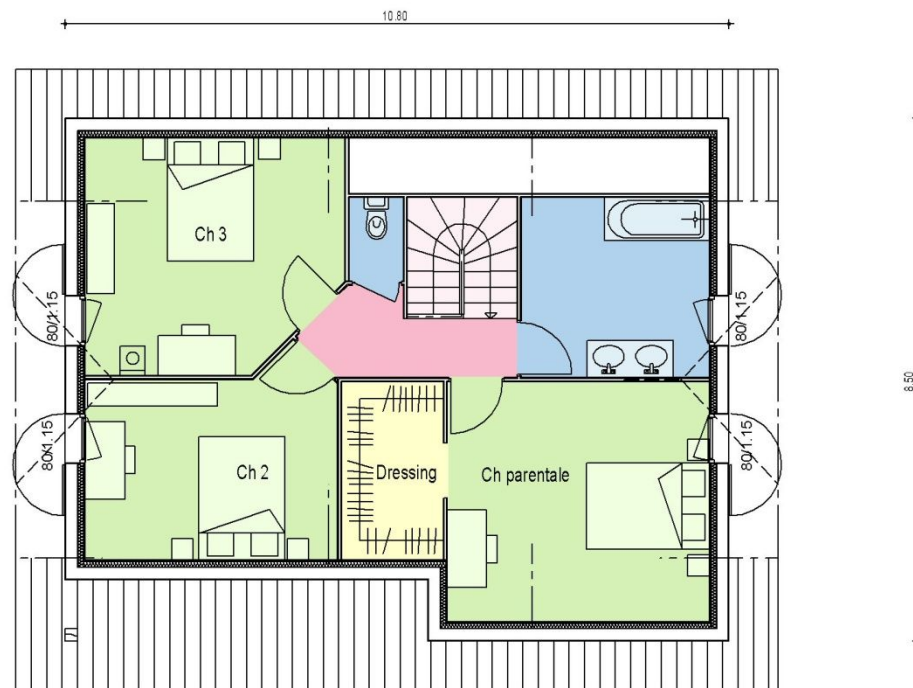

Etage

Bains	8.95 m ²
Bureau	11.38 m ²
Cave	36.70 m ²
Cellier	2.65 m ²
Chambre 2	12.47 m ²
Chambre 3	15.16 m ²
Chambre parents	16.59 m ²
Cuisine	10.81 m ²
Degt.	3.82 m ²
Dressing	4.78 m ²
Entrée	7.00 m ²
Escalier	3.65 m ²
Garage	36.50 m ²
Rangt.	2.61 m ²
Salon	32.13 m ²
WC	1.19 m ²
WC	1.56 m ²
SURFACE AMENAGEE	134.75 m²
SURFACE HABITABLE	122.01 m²
SURFACE ANNEXES	73.20 m²

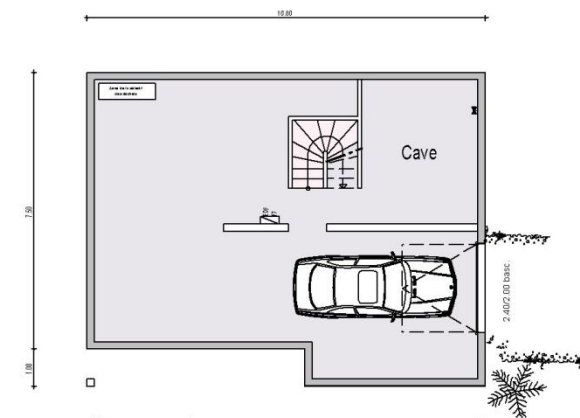

Sous sol

Giotto 148

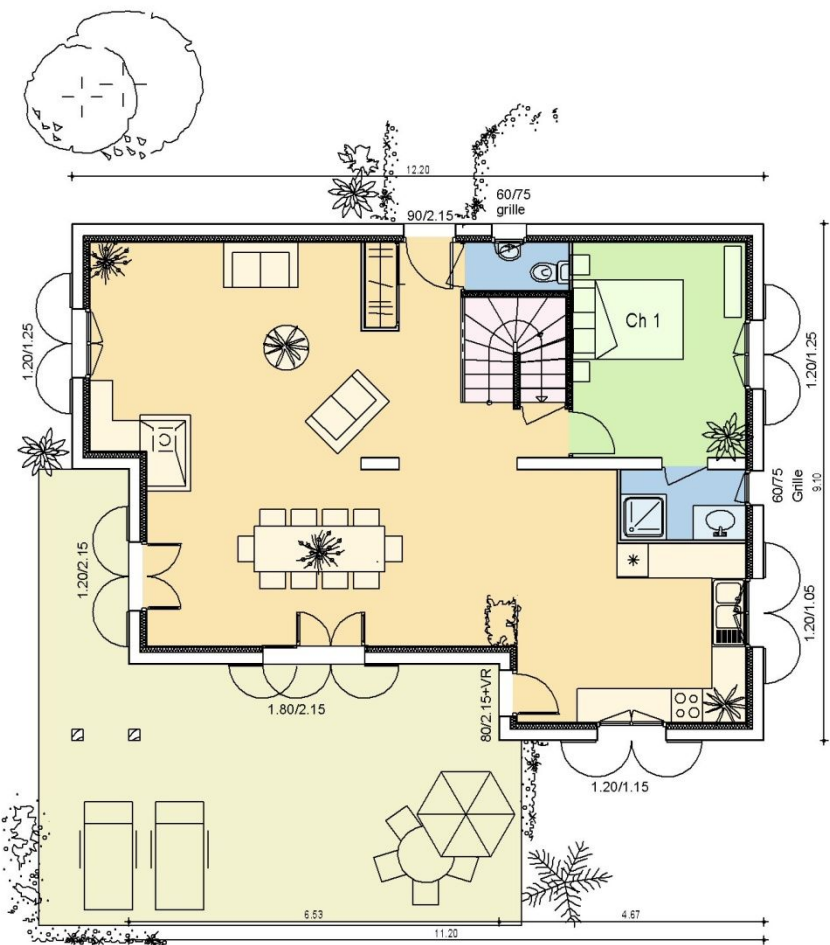

Rez de chaussée

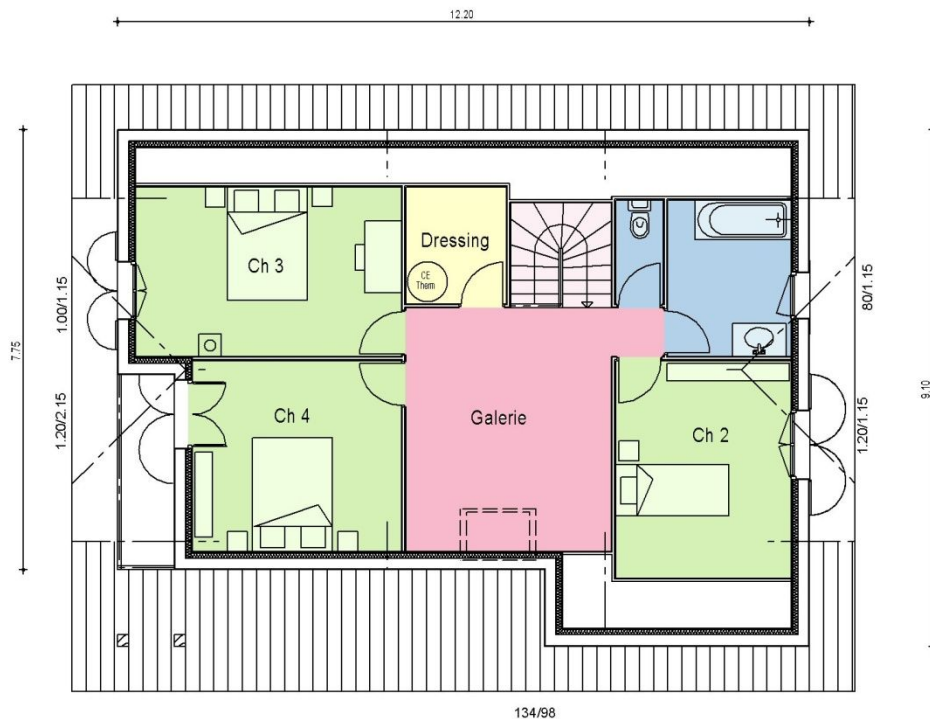

Etage

Bains	2.71 m ²
Bains	6.03 m ²
Cave	27.76 m ²
Chambre 1	11.56 m ²
Chambre 2	11.87 m ²
Chambre 3	14.02 m ²
Chambre 4	12.40 m ²
Chaufferie	14.70 m ²
Cuisine	14.98 m ²
Entrée	6.76 m ²
Escalier	3.44 m ²
Galerie	16.36 m ²
Garage	41.44 m ²
Rangt.	3.67 m ²
Salon	41.17 m ²
WC	1.55 m ²
WC	1.56 m ²
SURFACE AMENAGEE	148.07 m ²
SURFACE HABITABLE	140.01 m ²
SURFACE ANNEXES	83.90 m ²

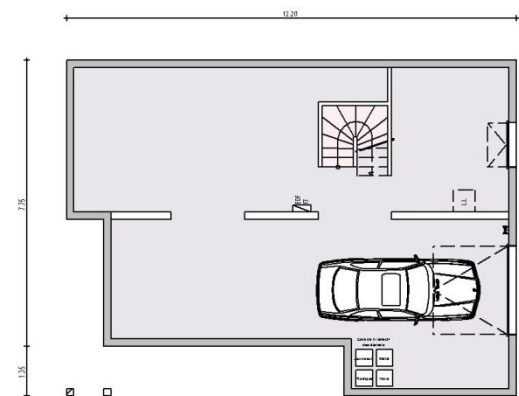

Sous sol